

User manual

Ironers

IB42310 – IB42314 – IB42316

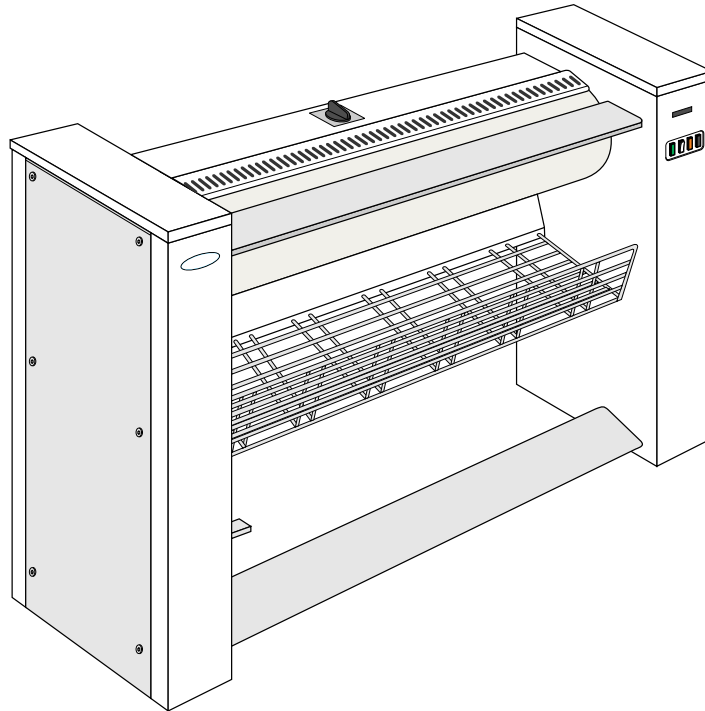

Originals instructions



Electrolux

01405013/EN

Contents

Contents

1	Precaution for use	5
2	Safety rules	5
3	General	5
4	Method of use	6
4.1	Description of the machine	6
4.2	Control devices	8
4.3	Finger protection device	8
4.4	Control pedal	9
4.5	Release device	9
5	Use	9
5.1	Starting the machine	9
5.2	Ironing machine with coin operating system	10
5.3	Coin operating system (option)	10
5.4	Temperature setting	11
5.5	Finger protection device	11
5.6	Ironing	11
5.7	Pressing function	12
5.8	Stopping the machine	12
5.9	Releasing of the cylinder	13
6	Use recommendations	13
7	Safety devices	14
8	Operating faults	15
9	Maintenance	15
9.1	Replacing cylinder coverings	16
9.2	Care instructions for the NOMEX textile	17
10	Symbols	17
11	Lubricant table	18
12	Explanation of washing symbols	18
12.1	Washing	19
12.2	Bleaching	19
12.3	Drying	20
12.4	Ironing	20
12.5	Dry or water cleaning	20

The manufacturer reserves the right to make changes to design and component specifications.

1 Precaution for use

- The machine should not be used by children.
- This ironing machine should only be used for previously washed and dried, machine-ironable textiles.
- Be careful with synthetic linen and also with printed linen. They can melt and stick on the cylinder.
- Do not iron articles that contain plastic, foam, sponge rubber or similarly textured rubberlike materials.

2 Safety rules

- Before any use, it is compulsory to read the instruction handbook.
- Users must have learnt how the machine operates.
- When ironing, do not wear loose or billowing garments (e.g. wide sleeves, ribbons, ties, etc...).
- Never iron if the hand protection bar is not operating.
- Do not iron linens coated with solvent, paint, wax, grease or any easily inflammable products.
- Do not put your hands between the raised bed and the cylinder to adjust or smooth out linen.
- Never smooth out linen by holding on to the inner corners of quilt covers, pillow cases, the shoulder straps of underwear or any other straps. Do not put your hands in the pockets of clothing.
- To prevent the risk of fire or explosion, never use flammable products to clean the machine.



Caution



For your personal safety, never use the machine without the protective housings.

3 General

This manual describes a heated ironer, available in 1 m, 1.40 m or 1.60 m ironing widths.

The bed is heated by heating elements.

This ironing machine is also available with a coin operating system.

The 1.40 m and 1.60 m ironing machines are supplied with an evacuation system.

An ironing speed variator is also available on option.

Note!

This machine contains no asbestos.

Identification plate

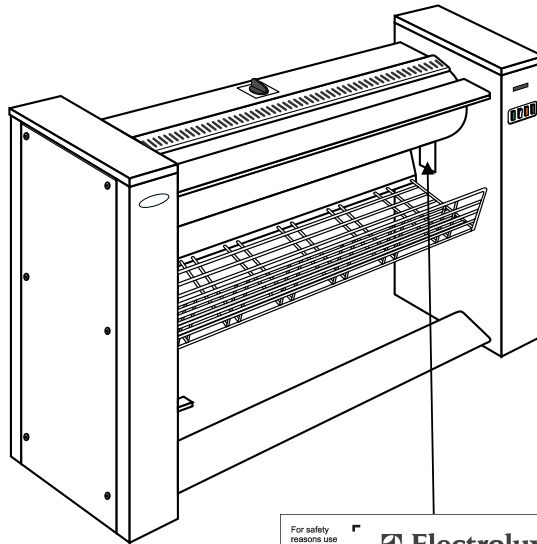

For safety reasons use only original spare parts.		Electrolux	
TYPE : _____		On (Hi) : _____ kW	
SERIAL N° : _____		G : _____ mbar	
QC N° : _____		Mn/Vn : _____ / _____	
PROD. N° : _____		Type : _____	
CAPACITY : _____ l ; _____ kg		G20 : _____ mbar	
P. MAX. : _____ W		G25 : _____ mbar	
(M) _____ kW ISOL. CLAS : _____		G30 : _____ mbar	
_____ W		G31 : _____ mbar	
V ~ Hz		T1 : _____	
_____ A		P. max. : _____ kPa	
CE _____ IP 24 D		Date : / /	
32101942		ELECTROLUX LAUNDRY SYSTEMS FRANCE 10430 Rosières-près-Troyes FRANCE Made in FRANCE	

4 Method of use

4.1 Description of the machine

- 1 "On" indicator lamp
- 2 "On-Off" switch
- 3 "Heating" indicator lamp
- 4 Potentiometer button "Ironing speed adjustment" (option with variator, speed adjustment from 1 to 4 m/min.)

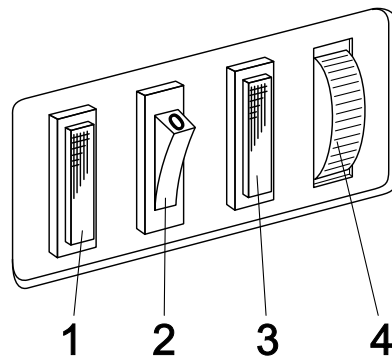

- | | |
|---|---|
| A | Pivoting sensitive protective device (finger guard) |
| B | Thermostat |
| C | Cylinder |
| D | Insertion table |
| E | Control device |
| F | Reception tray |

G
H

Control pedal
Bed release device (to be used in case of power failure)

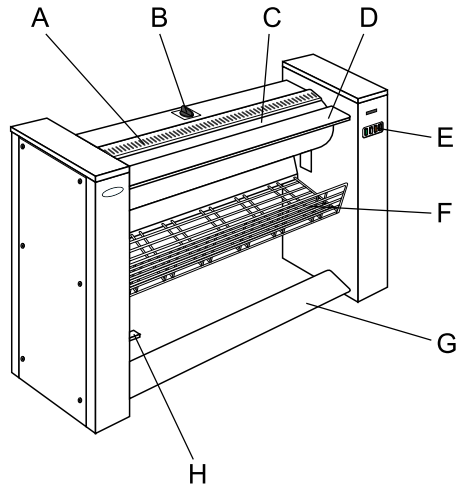

4.2 Control devices

1. "ON-OFF" switch.

This switch turns the ironing machine on and off. The green indicator light comes on as soon as the switch is on.

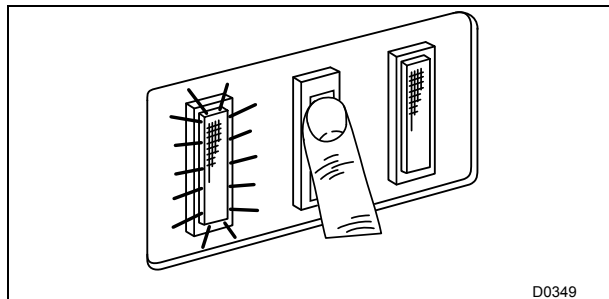

2. The yellow "HEATING ON" indicator light indicates that the heater is operating.

This indicator light goes out after a few minutes when the desired working temperature has been reached.

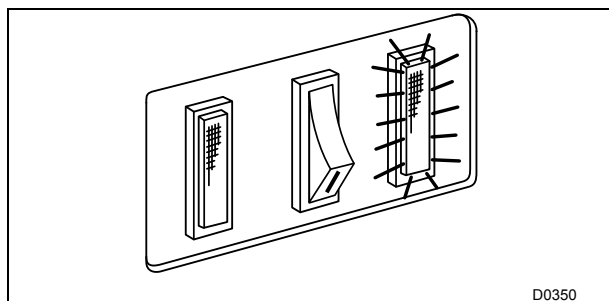

3. The "TEMPERATURE SELECTION" knob on the thermostat is used to set the temperature in function of the washing to be ironed.

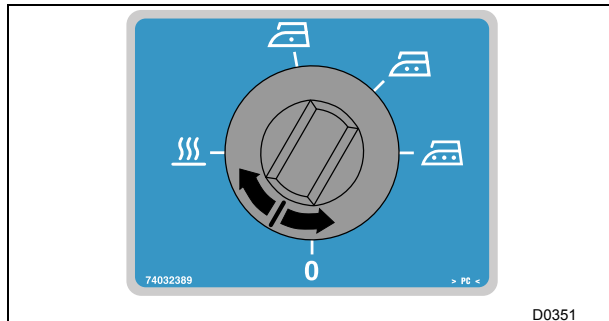

4.3 Finger protection device

Check that the finger protection device is operating prior to each use.

When this device is activated, the ironing machine stops, the cylinder stops turning and the tray moves back.

Press down on the control pedal to continue ironing.

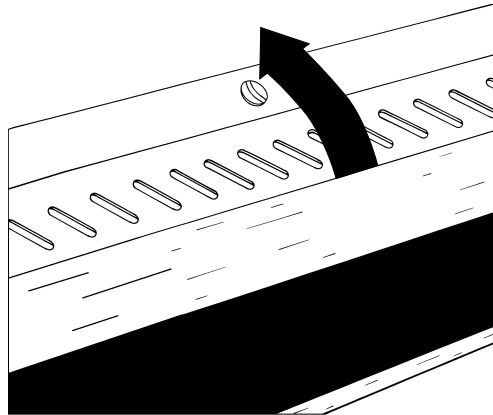

4.4 Control pedal

3 - position control pedal.

- Position 1 up (rest position)
- Position 2 intermediary (cylinder stop for pressing function)
- Position 3 down (ironing function or moving away of bed).

Note!

Push gently on the control pedal with your foot.

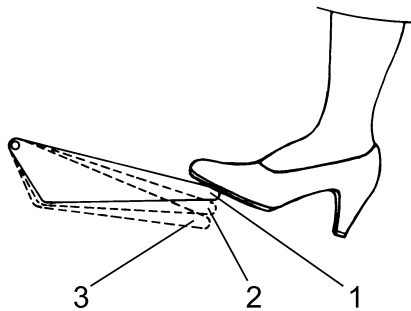

4.5 Release device

In the event of power failure, any garment in the machine can be removed by activating and then releasing with your foot this lever which separates the bed from the cylinder.

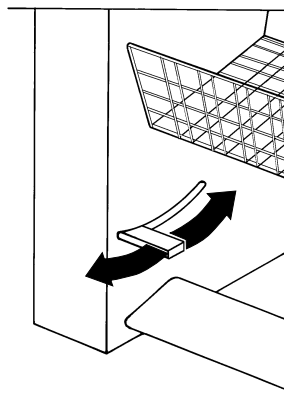

5 Use

5.1 Starting the machine

Turn on the main switch.

Press on the machine's white start button.
The green indicator lamp comes on.
Press down on the pedal to start ironing.

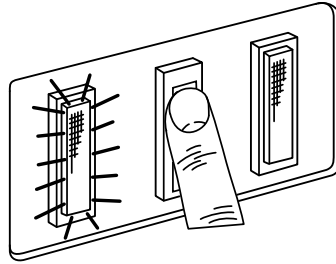

5.2 Ironing machine with coin operating system

Turn on the main switch.
Press on the machine's white start button.
Insert a coin.
The green indicator lamp comes on.
Press on the pedal to start ironing.

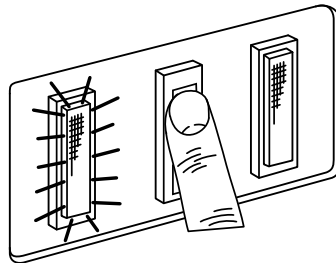

5.3 Coin operating system (option)

- 1 Coin machine
- 2 Insertion of coin
- 3 Coin return button
- 4 Coin return slot
- 5 Money collection box

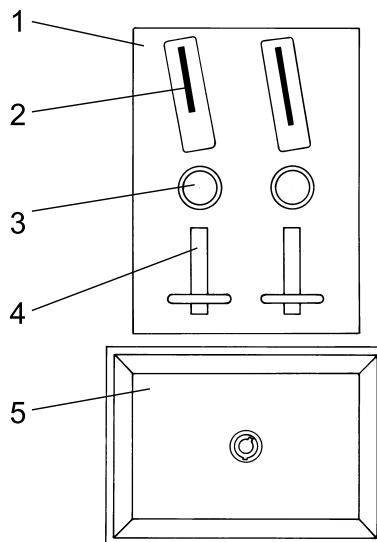

5.4 Temperature setting

Select the temperature in function of the article to be ironed.

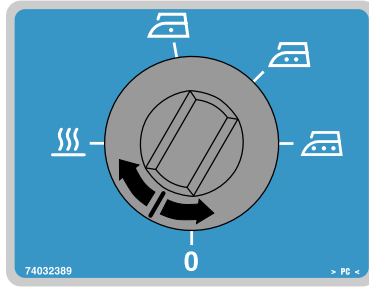

0 (zero)		Heating off
0 to 50 °C		Tepid
50 to 100 °C		Nylon, etc...
100 to 150 °C		Silk, Wood
150 to 170 °C		Cotton, Linen, Polycotton

As soon as the yellow "heating on" indicator light goes off, ironing can commence.

5.5 Finger protection device

Check that the finger protection device is operating prior to each use.

When this device is activated, the ironing machine stops, the cylinder stops turning and the bed comes away. Press on the control pedal to continue ironing.

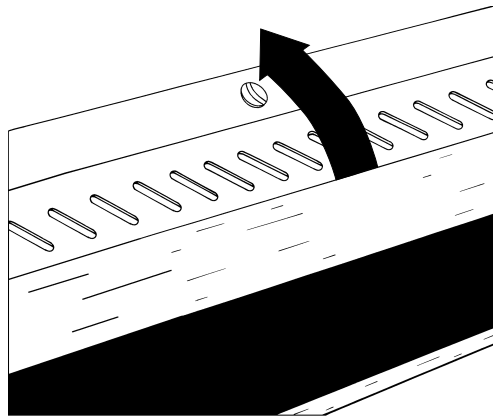

5.6 Ironing

Note!

Push gently on the control pedal with your foot.

When the pedal is in position 1 (rest position), the cylinder is stopped and the bed is in the rear position.

Press down then release the pedal a first time in position 2 or 3, the cylinder starts to turn and the bed advances towards it.

A new action in position 3 stops the cylinder, the bed moves back allowing the ironing to be placed on the cylinder.

Again press down on the pedal in position 2, the bed advances, the cylinder turns, taking up the article being ironed.

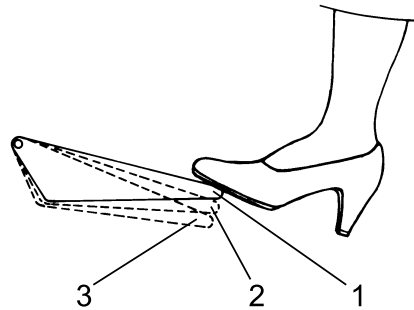

Place the ironing on the insertion table and push it so that it is taken up by the cylinder. Smooth out the linen starting at the centre and moving towards the edges. When there are buttons, they should be placed against the cylinder to protect them and the tray. For zippers and metal buttons, cover with a cloth to protect the bed.

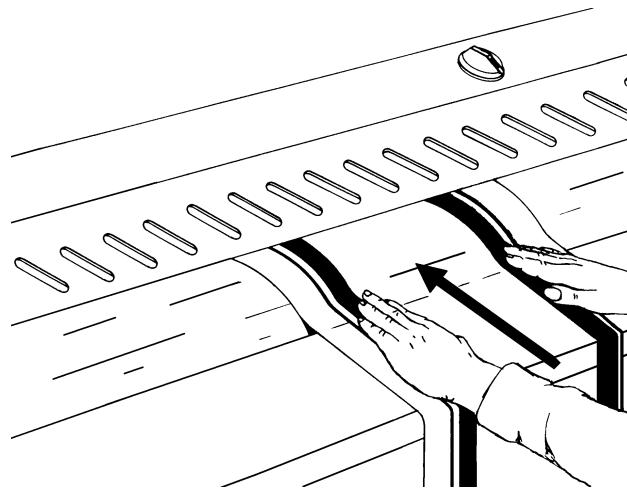

5.7 Pressing function

For the pressing function, move the control pedal to position 2; the cylinder stops.

To continue ironing, release the pedal.

To insert thicker items, press the pedal down to position 3, the cylinder stops and the bed moves away.

Position the article to be ironed and again press on the pedal to continue ironing.

Note!

Push gently on the control pedal with your foot.

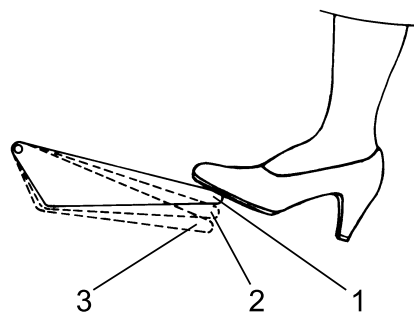

5.8 Stopping the machine

To get the maximum service life from the cylinder coverings, use the following procedure to stop ironing.

1. Position the thermostat to 0 to cut off the heating.
2. Let the cylinder turn in contact with the bed for a few minutes so as to eliminate the moisture from the coverings.

3. Press completely down on the pedal to move back the bed.
4. Turn off the switch to stop the machine.
5. Turn off the main switch.

5.9 Releasing of the cylinder

In some conditions of humidity or static electricity, it may happen that the piece of linen being ironed winds around the cylinder.

The cylinder can only rotate in one way; it is so, necessary in this precise case, to act on the machine.

1. Turn off the heating and stop the ironer.
2. Cut off the electrical supply by the main switch.
3. Remove the right lateral casing.
4. Unscrew and remove totally the knurled button (A) as well as the conical washer (B), the cylinder is now released.
5. Pull to you the piece of linen to unwind.
6. Make the cylinder turn slowly until seeing the threading of the knurled button.
7. Reassemble the conical washer (B) and the knurled button (A).
8. Reassemble the right lateral casing.
9. Rearm the main switch and start again the ironing.

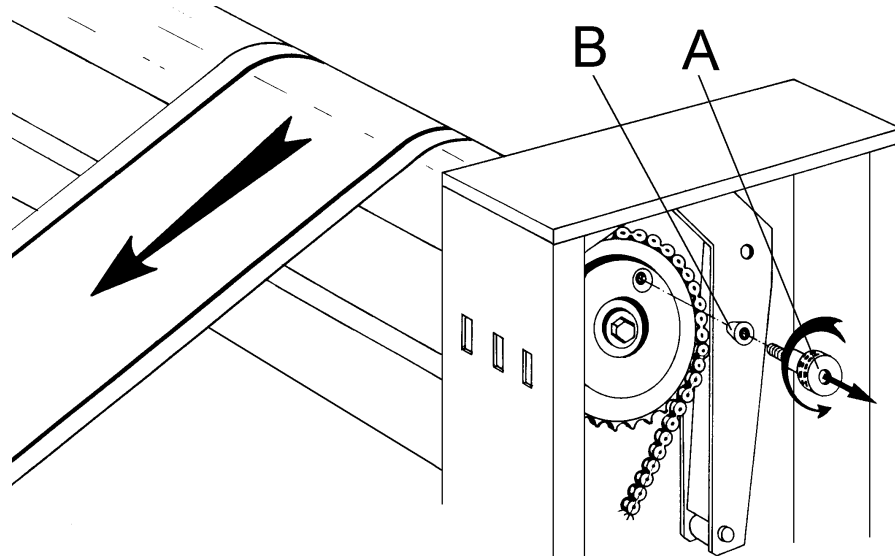

6 Use recommendations

- Make sure that the fabric can be ironed, and check which temperature should be used.
- Take care with synthetic and printed fabrics as these can melt and stick to the tray.
- It is advisable to commence ironing with the most delicate fabrics finishing off with the most heat-resistant ones, by progressively increasing the temperature with the thermostat button.
- When ironing small articles, use the entire width of the cylinder so that heat is evenly distributed, preventing wear on only one side of the covering.
- Iron starched articles last, to prevent any eventual residue on the bed from damaging other items.
- Do not iron overly thick linen or covers.
- Do not iron non heat-resistant or overly voluminous buttons (round buttons, for example).
- Carefully inserting the articles to be ironed will improve results.
- Make sure that the width of the ironing does not exceed the useful width of the machine.
- When ironing small items, be sure to alternatively use the full width of the roller (and not simply the middle); this prevents depressions from forming in the middle of the covering. This can effect the quality of the ironing (see figure below).
- When ironing is finished, let the cylinder turn for a few minutes to allow for the evaporation of any humidity absorbed during ironing.
- Let the bed move back before turning off the machine.

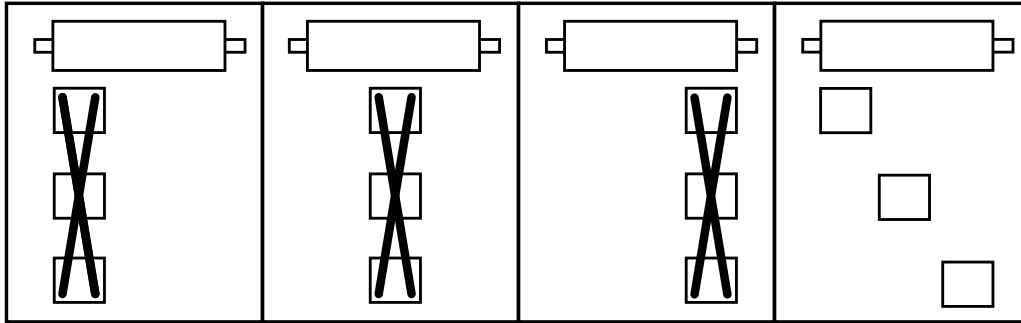

Important



It is very important that the machine is not running cold, the grip between the cylinder and the chest is too important which can prematurely wear out the cylinder padding and deteriorate the free wheel. Failure to follow this recommendation would void the warranty of the parts in question.

The outer padding being a consumable, it is normal to replace it periodically.

7 Safety devices

- | | |
|-------------------------------|--|
| Finger safety system | The space between the finger guard and the ironing cylinder does not allow fingers to pass through. As soon as the device is triggered, the bed moves away and the cylinder stops. |
| Accessibility | Housings can only be dismantled with a special tool. |
| Heating safety | Two safety thermostats limit the temperature of the bed. |
| Electrical protective devices | The motor is protected by a thermal contact. A fuse protects the machine's electrical control circuit (see installation manual). |



Make sure the machine is disconnected from the mains before repairing or servicing.



Do not use the machine unless it is plugged into a correctly earthed power socket complying with standards in force.



Warning



Any repairing or maintenance operation should be carried out by a specialist.



Important



The temperature of the ironing tray can, after use, reach 200 °C (392 °F) and, if touched, can cause serious burns. Let the machine cool down before carrying out any repairs or servicing.



Important



Never iron if the mobile safety protector (hand protection bar) is not operating.



Warning



For your personal safety, never use the machine without the protective housings.



Danger



The presence of dangerous mechanisms inside the machine can cause serious injuries. Respect all safety instructions before doing any work on the machine. Replace protective casings after doing any work.

8 Operating faults

The heating works incorrectly or not at all

- Check the preselected temperature.
- Check the adjustment thermostat.
- Check the activation of the heating contactor.
- Check the intensity of the heating elements.
- Check heating element connections.
- Check the phases (voltage and intensities).
- Check and reset the safety thermostat (see figures below).

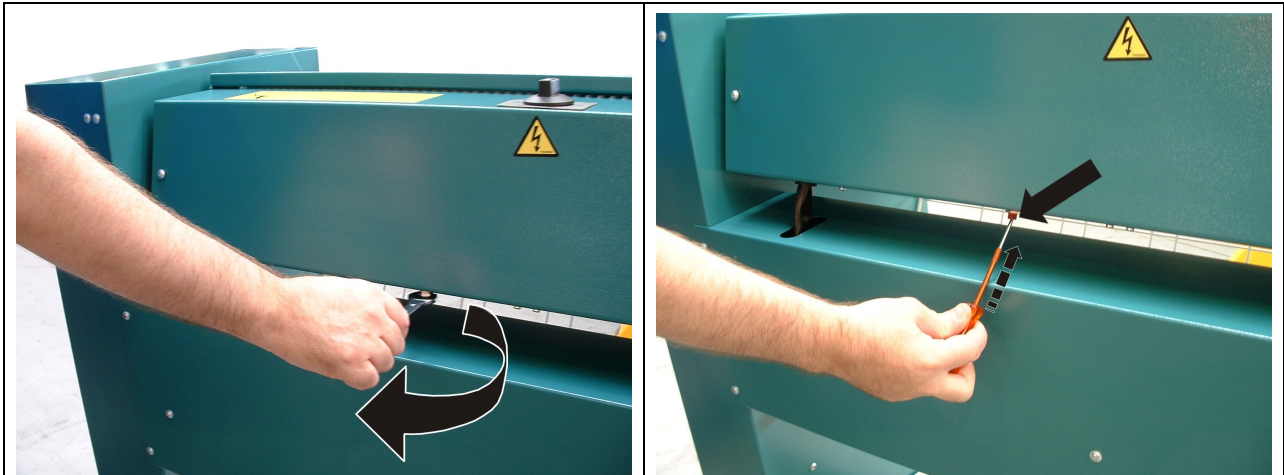

The machine suddenly stops

- Check the protective fuse.
- Check the electric power supply.
- Check the limit switches.
- Check the operating of the movement motor.

The temperature of the tray is too high

- Check the thermostat by measuring the temperature of the bed with a thermometer.
- Check that the thermostat's sensor is in contact with the bed.

9 Maintenance



Caution



Disconnect the power supply and leave the ironing bed to cool down prior to any repair work or servicing. To get the best results and optimum safety from your machine, observe all the servicing instructions.



Important



The bed has to be maintained with care so that the ironing is easy and of good quality.
 The removal of detergent or fur deposits should be done as soon as these are prejudicial to the ironing quality.
 The use of emery cloth or steel wool is strictly unadvised.
 We recommend you to only use a 3M product such as Scotch-Brite Ref. CFR A MEDIUM (Art. no 35003153).

Each day

- Check finger guard operating. This safety device must be checked before each use. If the device is activated, the cylinder should stop and the bed draw back. Press on the pedal to reactivate the ironing machine.

Every week

- Clean the ventilation grille of the movement motor and fan.

Every 6 months

- To obtain the best ironing results, it is essential that the covering of the cylinder is kept clean and in good condition.
- Wash the cotton cloth with hot water. Replace the cloth slightly damp without ironing it (see next page).
- Check the circumference of the cylinder (see next page). Clean the machine inside and out.

Every year

- Check thermostat operating.
- Check the heating elements, cables and connections.
- Lubricate the transmission chain (see lubrication table).
- The reducer requires no servicing because it is sealed and life-lubricated.

9.1 Replacing cylinder coverings

The cylinder is lined with steel wool, covered with a layer of felt and a layer of cotton material.

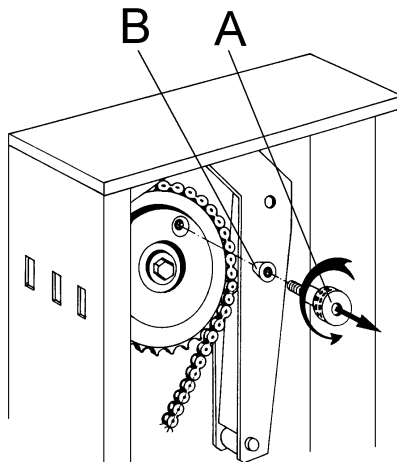

1. Stop the machine with the bed in back position.
2. Remove the right lateral casing.
3. Unscrew and remove totally the knurled button (A) and the conical washer (B), the cylinder is now released.
4. Untie the drawstrings at both ends of the cylinder.
5. Pull on the cotton padding to unroll it from the cylinder.
6. Do the same with the felt padding.
7. Reassemble the conical washer (B) and the knurled button (A).
8. Fit in a new felt padding as if it was a piece to iron, putting it edge to edge with the steel wool.
9. Turn manually the cylinder to wind the padding on half a turn.
10. Switch on the machine and turn the cylinder by pressing on the control treadle.
11. During this operation, the felt padding has to be stretched from the beginning to the end of the rolling-up.
12. Let the cylinder turn against the chest for 5 to 10 minutes in order for the felt padding to set up correctly.

13. Wash the cotton covering in hot water.
14. Replace the slightly damp cloth without ironing it.
15. Then, fit in the cotton cloth centring it on the cylinder as if it was a piece to iron, introducing it under the felt padding for about 10 cm.
16. Turn the cylinder to roll-up the cotton cloth.
17. Stop the machine, pull on the gather braids, tie them up correctly and fit them under the cotton cloth at the end of the cylinder. • Leave the cylinder heated turn for about one hour to run in the padding.
18. Check the diameter of the cylinder using a measuring tape.
19. The circumference of the cylinder should measure between: 690 mm minimum - 730 mm maximum.

Note!





If the steel wool lining is to be replaced, call on an after-sales service technician.

9.2 Care instructions for the NOMEX textile

The quality MNF/F3 NOMEX textile (option) can be washed with neutral detergents at 60 °C, whereby heavy or long mechanical effects should be avoided.

For de-watering, the textile should either only short extraction or be hung up to let it drip off. The textile is fitted onto the ironer in a damp condition and with light pressure and heating.

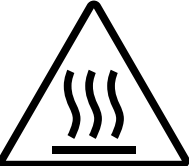
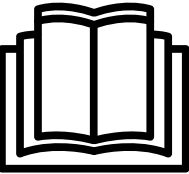
10 Symbols

	Caution.
	Caution, presence of dangerous current.
	Caution, hot surface.
	Read the instructions before using the machine.
	Warning, do not operate with casing removed.

11 Lubricant table

MACHINE LUBRICATION								
USES	Rolling bearings Bearings	Rolling bearings Bearings high temperature	Assembly paste (fretting corrosion)	Bare gears Chains shafts Thread Slides	Flange joints Union pipes Steam circuits	Reducers with wheels and screws	Reducers with gears	Circuits and pneumatic devices
TYPES OF LUBRICANTS AND STANDARDIZATION	Lithium soap grease	Lithium soap grease + silicone oil	Lithium soap paste + mineral oil + mineral solid greases	Lithium soap grease with MOS2 additive	Graphite grease mini 60% graphite, special leakproof	Extreme high pressure oil	Extreme high pressure oil	Inhibited oil SAE5
	Grade ISO NLGI2	Grade ISO NLGI3	Grade ISO NLGI1	Grade ISO NLGI2	Grade ISO NLGI2	Grade ISO VG150	Grade ISO VG220	Grade ISO VG22
TEMPERATURE LIMIT RANGE	-20°C + 140°C -4°F + 284°F	-40°C + 200°C -40°F + 392°F	-20°C + 150°C -4°F + 302°F	-20°C + 135°C -4°F + 275°F	-30°C + 700°C -22°F + 1292°F	-0°C + 100°C -32°F + 212°F	-20°C + 120°C -32°F + 248°F	+10°C + 65°C +50°F + 149°F
RECOMMENDED	CELTIA G2	NTN SH44 M	ALTEMP Q NB 50	MI-SETRAL 43N	GRACO AF 309	REDUCTELF SP150	REDUCTELF SP200	LUBRAK ATL SAE 5W
PRODUCT CODE	96 011 011	96 011 019	96 011 014	96 011 000	96 011 004	96 010 001	96 010 004	96 010 030
CORRESPONDENCE								
ANTAR	ROLEXA 2			EPOXA MO2		EPONA Z150	EPONA Z220	MISOLA AH
BP	LS EP2					ENERGOL CRXP150	ENERGOL CRXP220	SHF 22
CASTROL	SPEEROL EP2					ALPHA SP150	ALPHA SP220	
ELF	EP2			STATERMA MO10		REDUCTELF SP150	REDUCTELF SP220	SPINEF 22
ESSO	BEACON EP2			MULTI PURPOSE GREASE MOLY		SPARTAN EP150	SPARTAN EP220	SPINESSO 22
FINA	MARSON EP2					GIRAN SR150	GIRAN SR220	
GBSA					BELLEVILLE N			
GRAFOIL					GRACO AF309			
KLUBER	CENTOPLEX 2	UNISILKON L50Z	ALTEMP Q. NB50	UNIMOLY GL82	WOLFRA-COAT C	LAMORA 150	LAMORA 220	CRUCOLAN 22
MOBIL	MOBILUX					MOBILGEAR 629	MOBILGEAR 630	DTE 24
KERNITE	LUBRA KLC			LUBRA KMP		TOP BLENB ISO 80W90	TOP BLENB ISO 220	LUBRA K ATL SAE5W
SETRAL				MISETRAL 43N				
SHELL	ALVANIA R2			RETINA AM		OMALA 150	OMALA 220	TELLUS 22
TOTAL	MULTISS EP2					CARTER AP150	CARTER EP220	EQUIVIS 22
MOLYKOTE		MOLYKOTE 44	PATE DX					
OPAL	GERVAIR SP			SUPER MOS2		GEAROPAL GM65 ISO 150	GEAROPAL GM75 SO 220	HYDROPAL HO110 HM+ +22
ITECMA	GRL-ULTRA	VULCAIN	SILUB-P	GMO	LHT-C	DURAGEAR BL	DURAGEAR BL	AEROSYN
DOW CORNING		SH 44M						

To lubricate door mechanism of WSB5, use reference 96010068 Loctite LB 8001.















12 Explanation of washing symbols

(ISO 3758:2005 standard)

To overcome language barriers, the following are symbols used internationally to give you guidance and recommendations when washing different textiles.

12.1 Washing



The tub symbolizes washing.

Symbols	Max. washing temperature in °C	Mechanical action
	95	normal
	95	mild
	70	normal
	60	normal
	60	mild
	50	normal
	50	mild
	40	normal
	40	mild
	40	very mild
	30	normal
	30	mild
	30	very mild
	40	wash by hand
	-	do not wash

12.2 Bleaching



The triangle symbolizes bleaching.

Symbols	Explanation
	Bleaching allowed (chlorine or oxygen).

	Bleaching allowed (only oxygen).
	Do not bleach.





12.3 Drying

The circle in a square symbolizes tumble drying.

Symbols	Explanation
	Can be put in a tumble dryer. Normal temperature.
	Can be put in a tumble dryer. Lower temperature.
	Do not put in a tumble dryer.





12.4 Ironing



The iron symbolizes the domestic ironing and pressing process.

Symbols	Explanation
	Max. temperature 200 °C.
	Max. temperature 150 °C.
	Max. temperature 110 °C. The steam can cause irreversible damages.
	Do not iron.

12.5 Dry or water cleaning

The circle symbolizes dry or water cleaning.

Symbols	Explanation
	Normal dry cleaning with perchloroethyl, solvent of hydrocarb.
	Mild dry cleaning with perchloroethyl, solvent of hydrocarb.
	Normal dry cleaning with solvent of hydrocarbon.
	Mild dry cleaning with solvent of hydrocarbon.
	Do not dry clean.

	Normal water cleaning.
	Mild water cleaning.
	Very mild water cleaning.



Electrolux Laundry Systems Sweden AB
341 80 Ljungby, Sweden
www.electrolux.com/professional

Share more of our thinking at www.electrolux.com